

2.1GHz / 800MHz / 1.8GHz Bands Application

5-1 Summary

The characteristics of 2.1GHz/800MHz/1.8GHz bands have evaluated as follows. The evaluation circuit structure and measured data are reviewed.

5-2-1 Measurement data of assembled evaluation board

DC Characteristics

General conditions : $V_{DD}=2.8V$, $T_a=+25^{\circ}C$

Parameter	Symbol	Condition	Measurement data	Units
LNA Supply Voltage	V_{DD}		2.8	V
Control Voltage 1 (High)	$V_{CTL1(H)}$		1.8	V
Control Voltage 1 (Low)	$V_{CTL1(L)}$		0	V
Control Voltage 2 (High)	$V_{CTL2(H)}$		1.8	V
Control Voltage 2 (Low)	$V_{CTL2(L)}$		0	V
Control Voltage 3 (High)	$V_{CTL3(H)}$		1.8	V
Control Voltage 3 (Low)	$V_{CTL3(L)}$		0	V
LNA Operating Current 1 (2.1GHz High Gain Mode)	I_{DD1}	$V_{CTL1}=0V$, $V_{CTL2}=0V$, $V_{CTL3}=1.8V$	2.51	mA
LNA Operating Current 2 (800MHz High Gain Mode)	I_{DD2}	$V_{CTL1}=1.8V$, $V_{CTL2}=0V$, $V_{CTL3}=1.8V$	2.54	mA
LNA Operating Current 3 (1.8GHz High Gain Mode)	I_{DD3}	$V_{CTL1}=0V$, $V_{CTL2}=1.8V$, $V_{CTL3}=1.8V$	2.51	mA
LNA Operating Current 4 (Low Gain Mode)	I_{DD4}	$V_{CTL3}=0V$	32.2	uA
Control Current 1	I_{CTL1}	$V_{CTL1}=1.8V$	5.0	uA
Control Current 2	I_{CTL2}	$V_{CTL2}=1.8V$	4.9	uA
Control Current 3	I_{CTL3}	$V_{CTL3}=1.8V$	5.0	uA

5-2-2 Measurement data of assembled evaluation board

RF Characteristics 1 (2.1GHz Band High Gain Mode)

General condition : $V_{DD}=2.7V$, $V_{CTL1}=0V$, $V_{CTL2}=0V$, $V_{CTL3}=1.8V$, $f_{RF}=2110\sim 2170MHz$,

$T_a=+25^{\circ}C$, $Z_s=Z_l=50ohm$, with application circuit

Parameter	Condition	Symbol	Measurement Data	Units
Small Signal Gain 1	Exclude Input&Output PCB, Connector Losses (0.45dB)	Gain 1	15.7~16.0	dB
Isolation 1	Exclude Input&Output PCB, Connector Losses (0.45dB)	ISO 1	-29.9~-29.3	dB
Noise Figure 1	Exclude PCB, Connector Losses (0.09dB)	NF 1	1.29~1.30	dB
Input Power 1dB Compression 1		P-1dB(IN)_1	-9.6~-9.2	dBm
Input 3rd Order Intercept Point 1	$f_1=f_{RF}$, $f_2=f_{RF}+100kHz$, Pin=-30dBm	IIP3H1_1	-0.3~-0.1	dBm
RF IN VSWR 1		VSWRi_1	1.38~1.63	-
RF OUT VSWR 1		VSWRo_1	1.86~1.92	-

RF Characteristics 2 (2.1GHz Band Low Gain Mode)

General condition : $V_{DD}=2.7V$, $V_{CTL1}=0V$, $V_{CTL2}=0V$, $V_{CTL3}=0V$, $f_{RF}=2110\sim 2170MHz$,

$T_a=+25^{\circ}C$, $Z_s=Z_l=50ohm$, with application circuit

Parameter	Condition	Symbol	Measurement Data	Units
Small Signal Gain 2	Exclude Input&Output PCB, Connector Losses (0.45dB)	Gain 2	-3.6~-3.5	dB
Isolation 2	Exclude Input&Output PCB, Connector Losses (0.45dB)	ISO 2	-3.6~-3.5	dB
Noise Figure 2	Exclude PCB, Connector Losses (0.09dB)	NF 2	3.4~4.1	dB
Input Power 1dB Compression 2		P-1dB(IN)_2	+14.0~+14.3	dBm
Input 3rd Order Intercept Point 2	$f_1=f_{RF}$, $f_2=f_{RF}+100kHz$, Pin=-16dBm	IIP3_2	+10.8~+11.8	dBm
RF IN VSWR 2		VSWRi_2	1.21~1.43	-
RF OUT VSWR 2		VSWRo_2	1.62~1.76	-

5-2-3 Measurement data of assembled evaluation board

RF Characteristics 3 (800MHz Band High Gain Mode)

General condition : $V_{DD}=2.7V$, $V_{CTL1}=1.8V$, $V_{CTL2}=0V$, $V_{CTL3}=1.8V$, $f_{RF}=869\sim 900MHz$,

$T_a=+25^{\circ}C$, $Z_s=Z_l=50\Omega$, with application circuit

Parameter	Condition	Symbol	Measurement Data	Units
Small Signal Gain 3	Exclude Input&Output PCB, Connector Losses (0.22dB)	Gain 3	15.9~16.0	dB
Isolation 3	Exclude Input&Output PCB, Connector Losses (0.22dB)	ISO 3	-34.7~-34.4	dB
Noise Figure 3	Exclude PCB, Connector Losses (0.06dB)	NF 3	1.31~1.44	dB
Input Power 1dB Compression 3		P-1dB(IN)_3	-9.4~-9.3	dBm
Input 3rd Order Intercept Point 3	$f_1=f_{RF}$, $f_2=f_{RF}+100kHz$, Pin=-30dBm	IIP3H1_3	-2.8~-2.1	dBm
RF IN VSWR 3		VSWRi_3	1.62~1.73	-
RF OUT VSWR 3		VSWRo_3	2.21~2.34	-

RF Characteristics 4 (800MHz Band Low Gain Mode)

General condition : $V_{DD}=2.7V$, $V_{CTL1}=1.8V$, $V_{CTL2}=0V$, $V_{CTL3}=0V$, $f_{RF}=869\sim 900MHz$,

$T_a=+25^{\circ}C$, $Z_s=Z_l=50\Omega$, with application circuit

Parameter	Condition	Symbol	Measurement Data	Units
Small Signal Gain 4	Exclude Input&Output PCB, Connector Losses (0.22dB)	Gain 4	-3.1~-3.0	dB
Isolation 4	Exclude Input&Output PCB, Connector Losses (0.22dB)	ISO 4	-3.1~-3.0	dB
Noise Figure 4	Exclude PCB, Connector Losses (0.06dB)	NF 4	3.0~3.9	dB
Input Power 1dB Compression 4		P-1dB(IN)_4	+17.1~+17.7	dBm
Input 3rd Order Intercept Point 4	$f_1=f_{RF}$, $f_2=f_{RF}+100kHz$, Pin=-20dBm	IIP3_4	+13.8~+14.5	dBm
RF IN VSWR 4		VSWRi_4	1.26~1.38	-
RF OUT VSWR 4		VSWRo_4	1.66~1.75	-

5-2-4 Measurement data of assembled evaluation board

RF Characteristics 5 (1.8GHz Band High Gain Mode)

General condition : $V_{DD}= 2.7V$, $V_{CTL1}=0V$, $V_{CTL2}=1.8V$, $V_{CTL3}=1.8V$, $f_{RF}=1805\sim 1880MHz$,
 $T_a=+25^{\circ}C$, $Z_s=Z_l=50ohm$, with application circuit

Parameter	Condition	Symbol	Measurement Data	Units
Small Signal Gain 5	Exclude Input&Output PCB, Connector Losses (0.41dB)	Gain 5	15.7 ~ 15.9	dB
Noise Figure 5	Exclude PCB, Connector Losses (0.10dB)	NF 5	1.35 ~ 1.41	dB
Input Power 1dB Compression 5		P-1dB(IN)_5	-7.8 ~ -7.1	dBm
Input 3rd Order Intercept Point 5	$f_1=f_{RF}$, $f_2=f_{RF}+100kHz$, Pin=-30dBm	IIP3_5	+1.0 ~ +1.8	dBm
RF IN VSWR 5		VSWRi_5	1.76 ~ 1.93	-
RF OUT VSWR 5		VSWRo_5	1.78 ~ 1.79	-

RF Characteristics 6 (1.8GHz Band Low Gain Mode)

General condition : $V_{DD}= 2.7V$, $V_{CTL1}=0V$, $V_{CTL2}=1.8V$, $V_{CTL3}=0V$, $f_{RF}=1805\sim 1880MHz$,
 $T_a=+25^{\circ}C$, $Z_s=Z_l=50ohm$, with application circuit

Parameter	Condition	Symbol	Measurement Data	Units
Small Signal Gain 6	Exclude Input&Output PCB, Connector Losses (0.41dB)	Gain 6	-4.0 ~ -3.9	dB
Noise Figure 6	Exclude PCB, Connector Losses (0.10dB)	NF 6	3.9 ~ 4.7	dB
Input Power 1dB Compression 6		P-1dB(IN)_6	+17.4 ~ +17.7	dBm
Input 3rd Order Intercept Point 6	$f_1=f_{RF}$, $f_2=f_{RF}+100kHz$, Pin=-16dBm	IIP3_6	+13.3 ~ +14.1	dBm
RF IN VSWR 6		VSWRi_6	1.67 ~ 1.72	-
RF OUT VSWR 6		VSWRo_6	2.14 ~ 2.24	-

5-3 Pin configuration

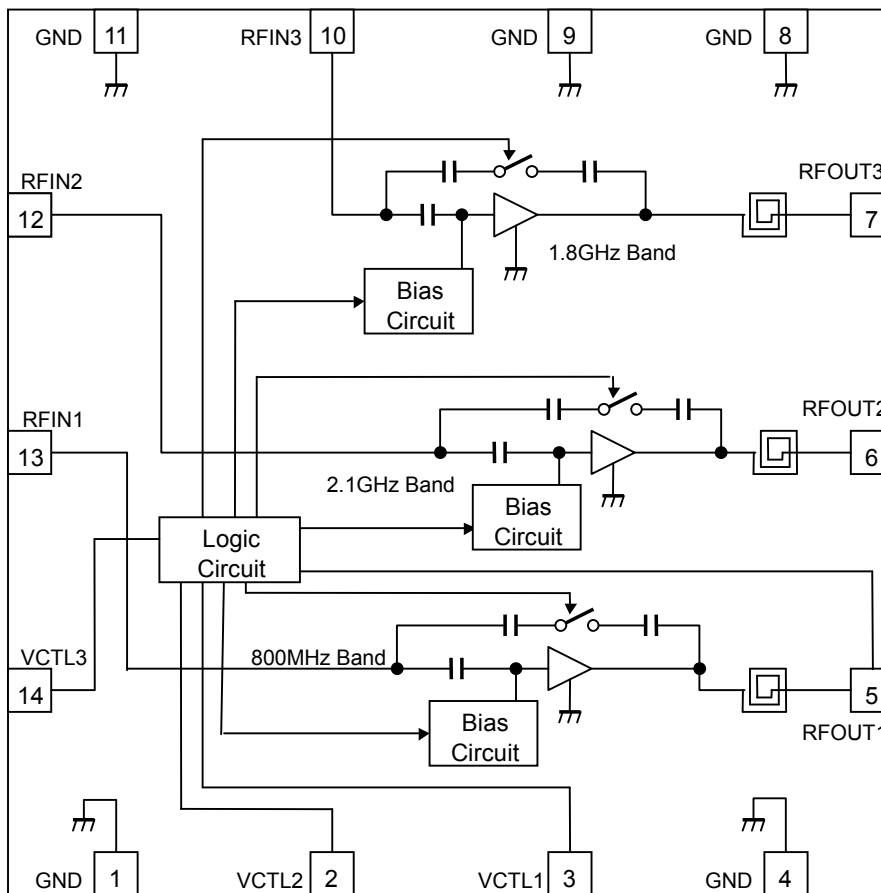

VCTL terminal function

VCTL1, VCTL2 : Band Select (2.1GHz or 800MHz or 1.8GHz)

VCTL3 : RX ATT Select (High Gain mode or Low Gain mode)

5-4 Truth table

Control Voltage			State					
V _{CTL1}	V _{CTL2}	V _{CTL3}	2.1GHz Band		800MHz Band		1.8 GHz Band	
(Band Sel1)	(Band Sel2)	(RX ATT)	LNA I _{DD}	Bypass	LNA I _{DD}	Bypass	LNA I _{DD}	Bypass
L	L	L	OFF	ON	OFF	ON	OFF	ON
L	L	H	ON	OFF	OFF	OFF	OFF	OFF
H	L	L	OFF	ON	OFF	ON	OFF	ON
H	L	H	OFF	OFF	ON	OFF	OFF	OFF
L	H	L	OFF	ON	OFF	ON	OFF	ON
L	H	H	OFF	OFF	OFF	OFF	ON	OFF
H	H	L	OFF	ON	OFF	ON	OFF	ON
H	H	H	OFF	OFF	OFF	OFF	ON	OFF

5-5-1 Typical characteristics (2.1GHz Band High Gain Mode)

Condition: $T_a=+25^{\circ}\text{C}$, $V_{DD}=2.7\text{V}$, $V_{CTL1}=0\text{V}$, $V_{CTL2}=0\text{V}$, $V_{CTL3}=1.8\text{V}$

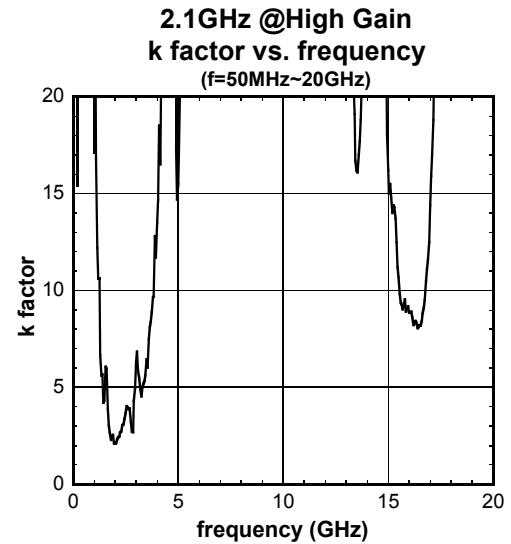
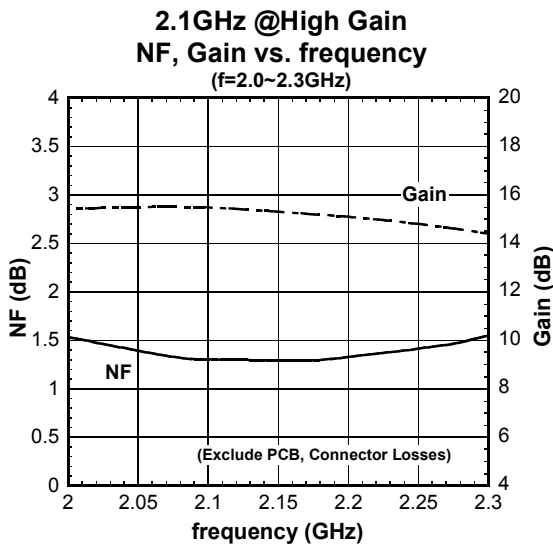
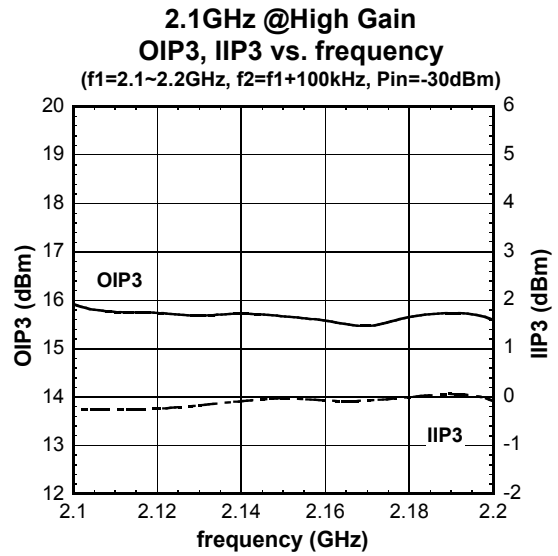
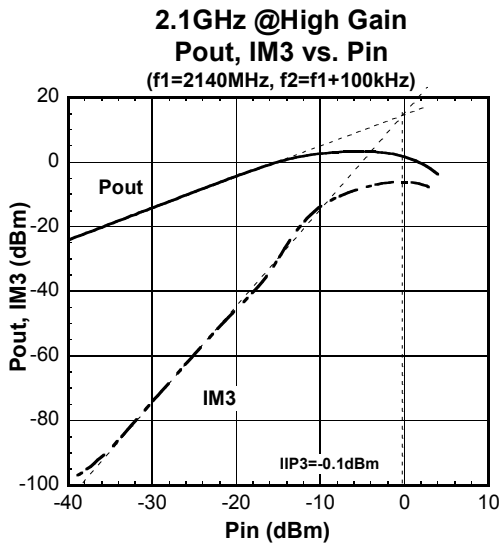
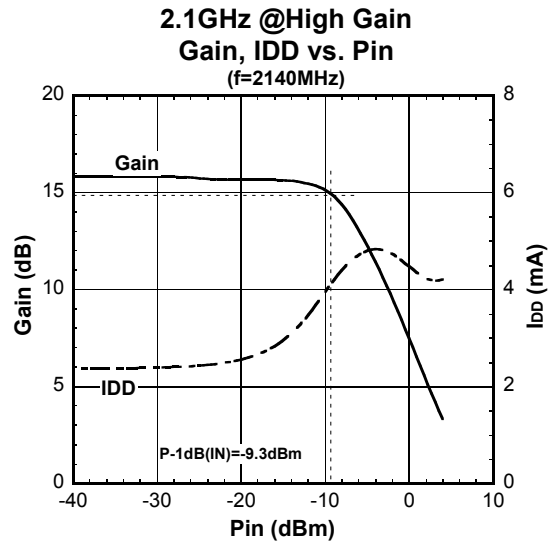
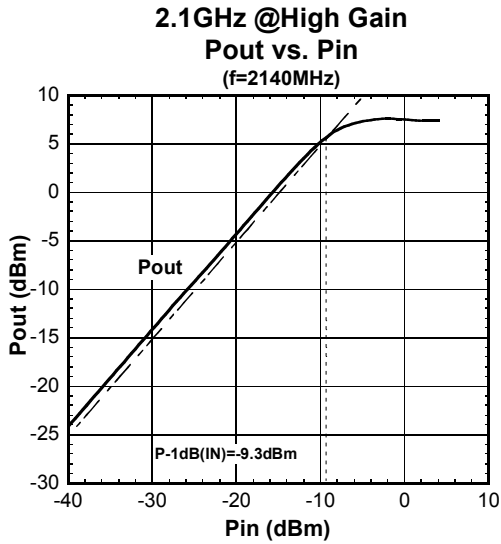

5-5-2 Typical characteristics (2.1GHz Band High Gain Mode)

Condition: $T_a=+25^{\circ}\text{C}$, $V_{DD}=2.7\text{V}$, $V_{CTL1}=0\text{V}$, $V_{CTL2}=0\text{V}$, $V_{CTL3}=1.8\text{V}$

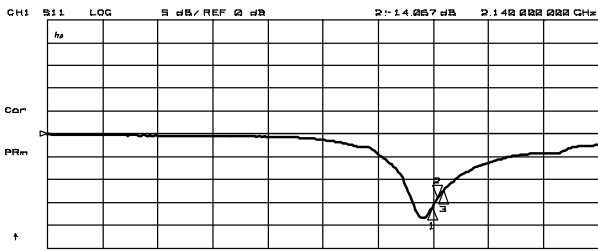

CH1 Markers
 1: -15.896 dB
 2.11000 GHz
 3: -12.454 dB
 2.17000 GHz

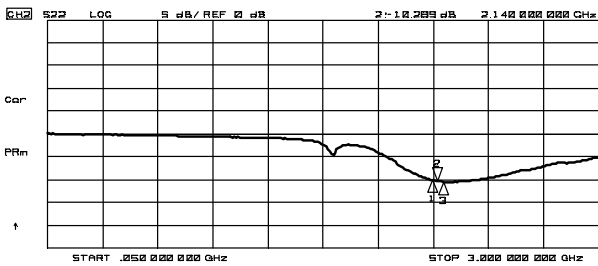

CH2 Markers
 1: -10.092 dB
 2.11000 GHz
 3: -10.568 dB
 2.17000 GHz

S11, S22

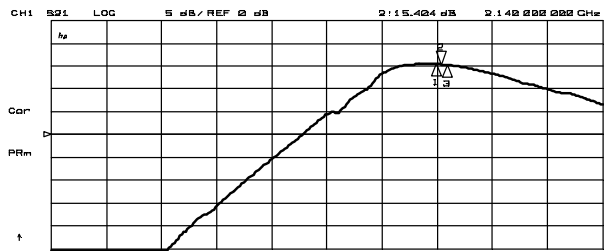

CH1 Markers
 1: 15.516 dB
 2.11000 GHz
 3: 15.266 dB
 2.17000 GHz

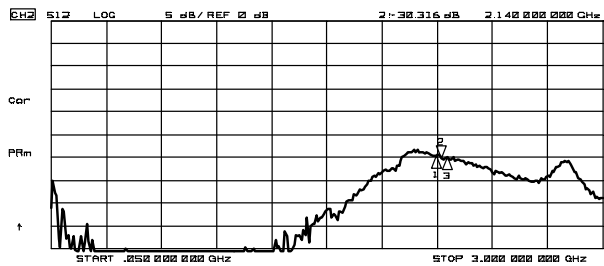

CH2 Markers
 1: 29.782 dB
 2.11000 GHz
 3: 30.026 dB
 2.17000 GHz

S21, S12



CH1 Markers
 1: 1.3818
 2.11000 GHz
 3: 1.6324
 2.17000 GHz

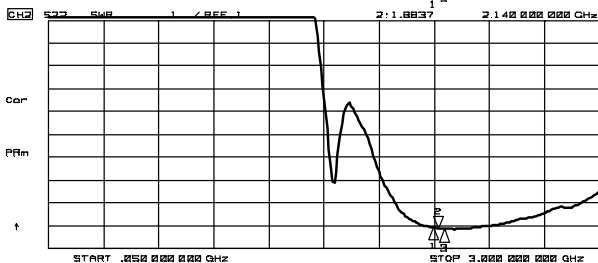

CH2 Markers
 1: 1.9192
 2.11000 GHz
 3: 1.8504
 2.17000 GHz

VSWR

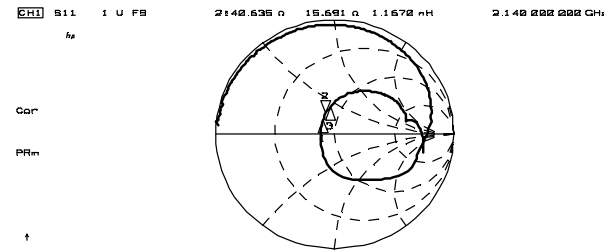

CH1 Markers
 1: 38.883 n
 19.275 n
 2.11000 GHz
 3: 41.715 n
 28.813 n
 2.17000 GHz

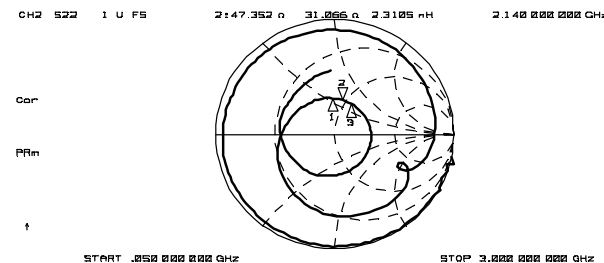

CH2 Markers
 1: 48.078 n
 27.783 n
 2.11000 GHz
 3: 56.586 n
 32.438 n
 2.17000 GHz

Zin, Zout

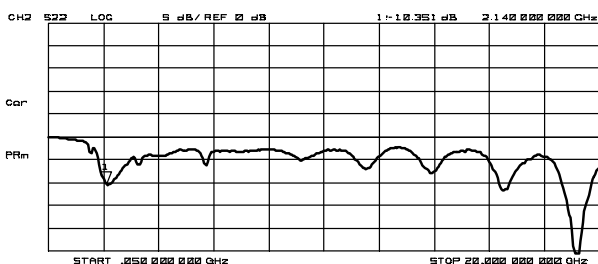
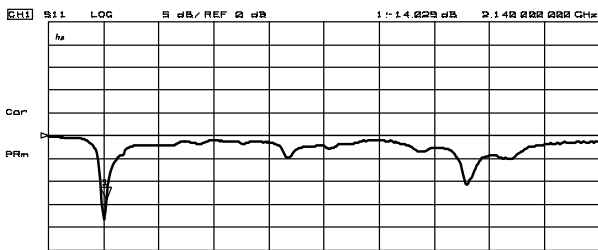

S11, S22
 (f=50MHz~20GHz)

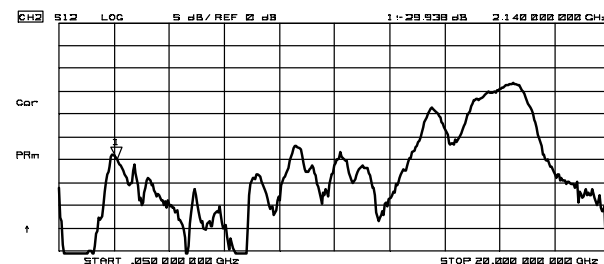
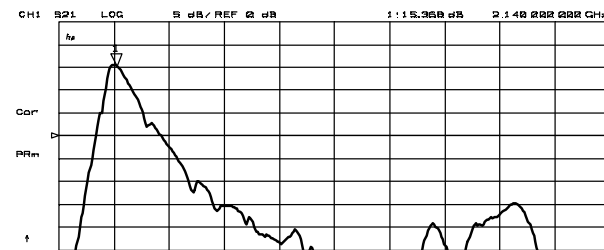

S21, S12
 (f=50MHz~20GHz)

5-5-3 Typical characteristics (2.1GHz Band Low Gain Mode)

Condition: $T_a=+25^{\circ}\text{C}$, $V_{DD}=2.7\text{V}$, $V_{CTL1}=0\text{V}$, $V_{CTL2}=0\text{V}$, $V_{CTL3}=0\text{V}$

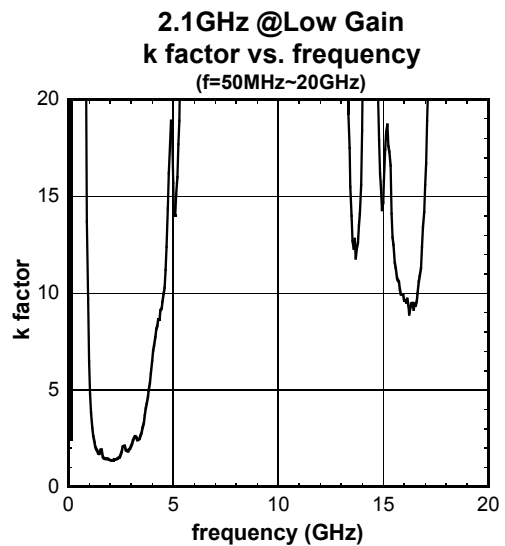
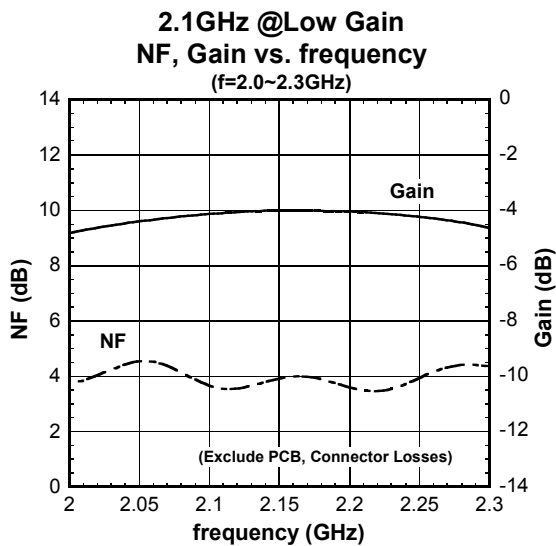
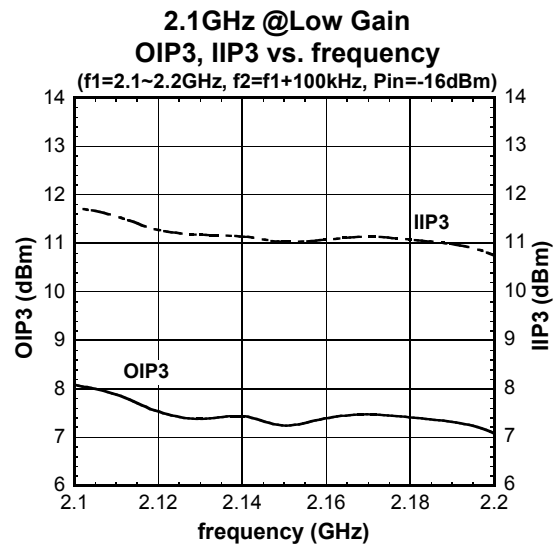
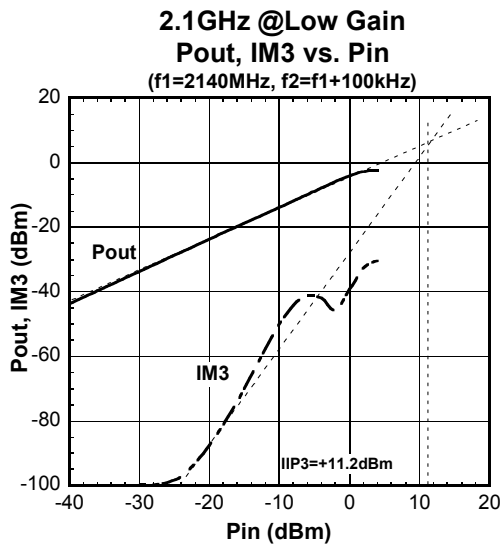
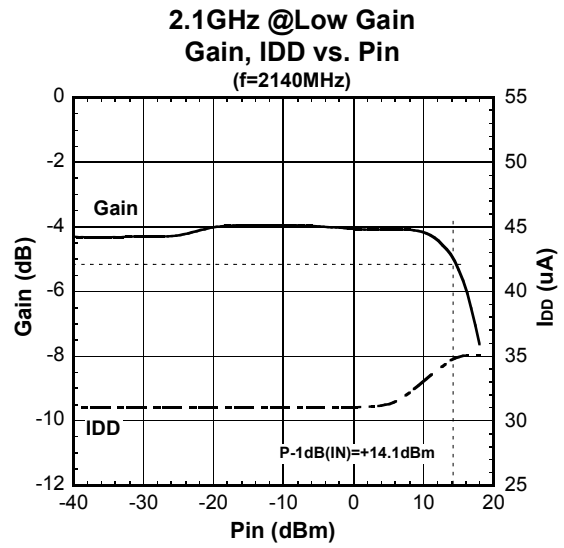
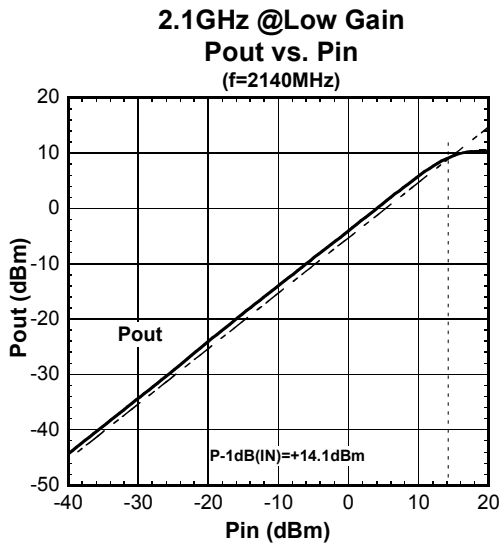

5-5-4 Typical characteristics (2.1GHz Band Low Gain Mode)

Condition: $T_a=+25^{\circ}\text{C}$, $V_{DD}=2.7\text{V}$, $V_{CTL1}=0\text{V}$, $V_{CTL2}=0\text{V}$, $V_{CTL3}=0\text{V}$

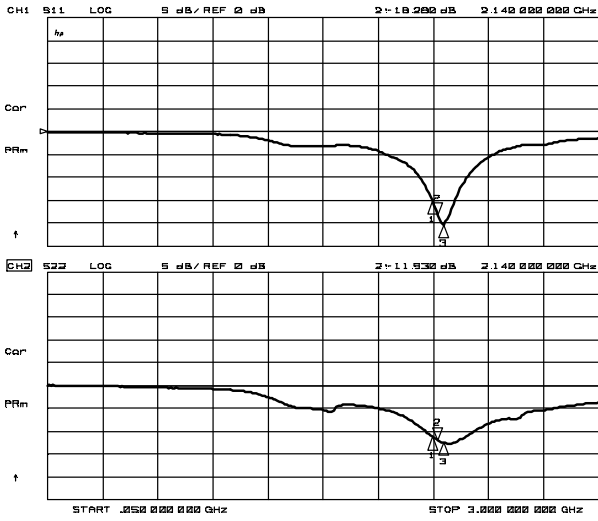

S11, S22

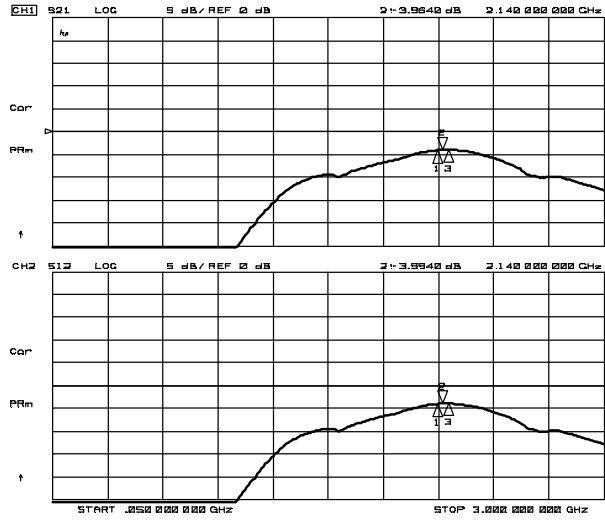

S21, S12

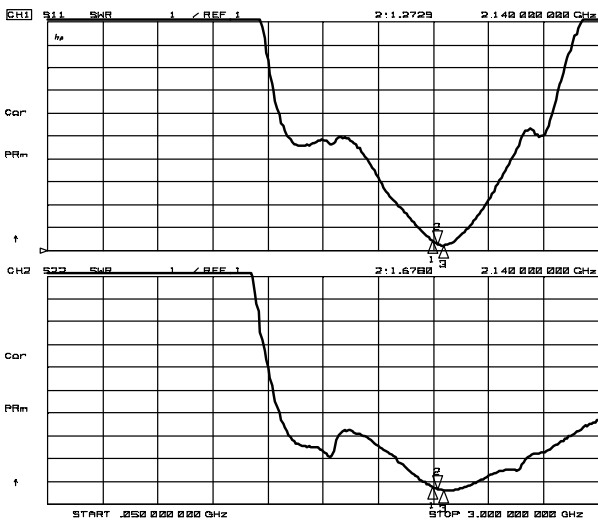

VSWR

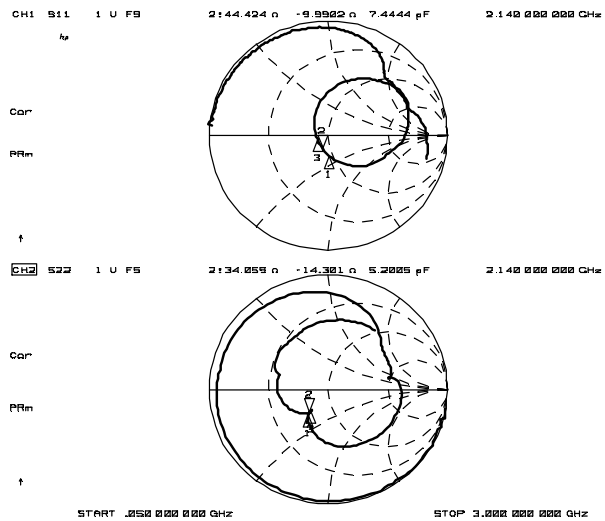

Zin, Zout

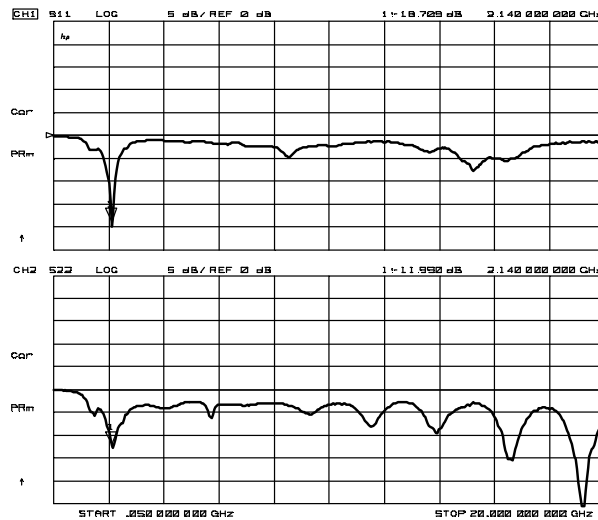

S11, S22
(f=50MHz~20GHz)

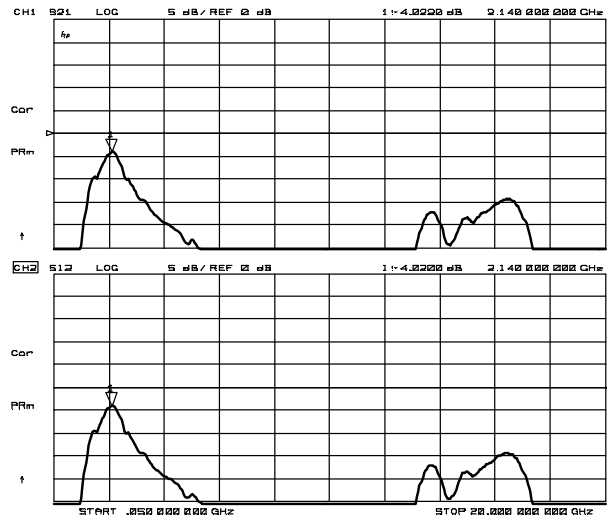

S21, S12
(f=50MHz~20GHz)

5-5-5 Typical characteristics (800MHz Band High Gain Mode)

Condition: $T_a = +25^\circ\text{C}$, $V_{DD} = 2.7\text{V}$, $V_{CTL1} = 1.8\text{V}$, $V_{CTL2} = 0\text{V}$, $V_{CTL3} = 1.8\text{V}$

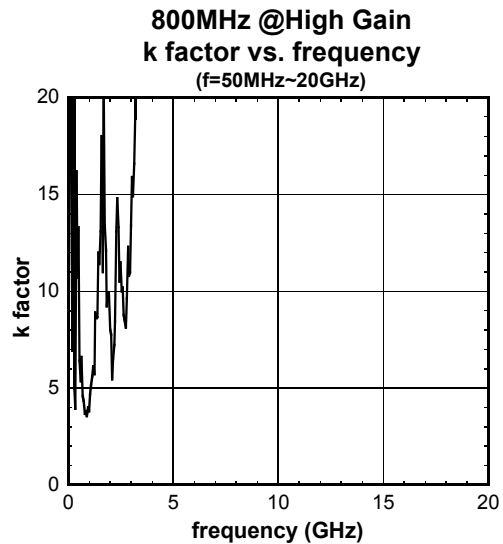
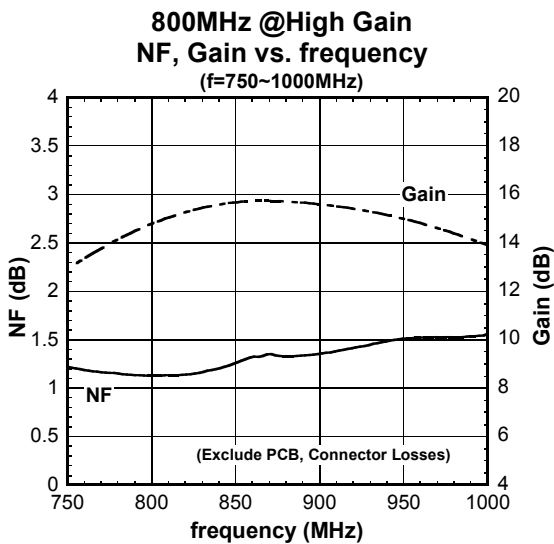
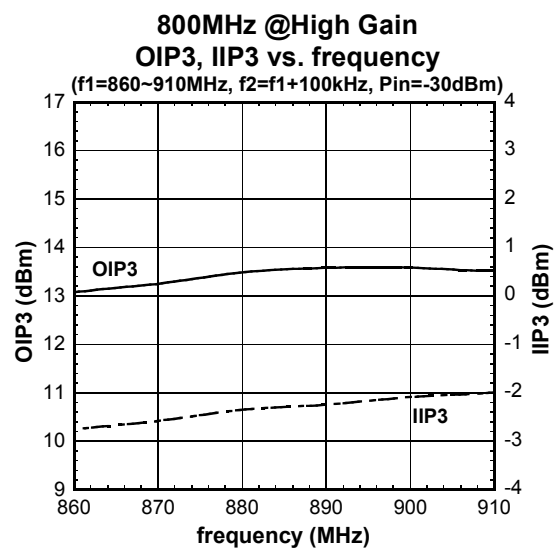
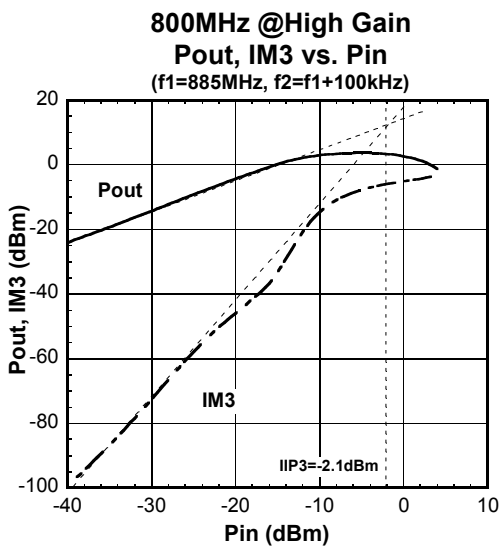
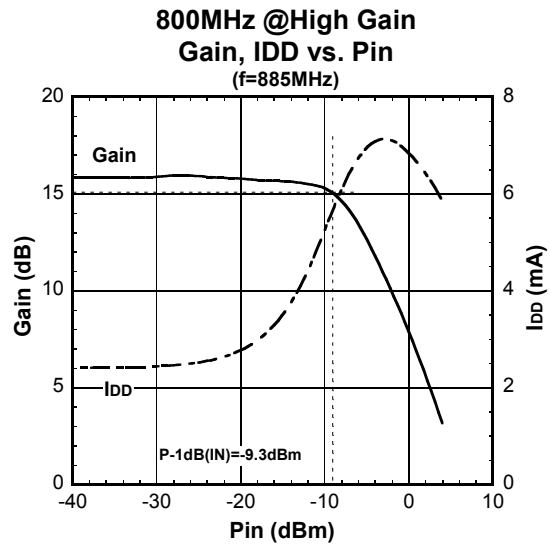
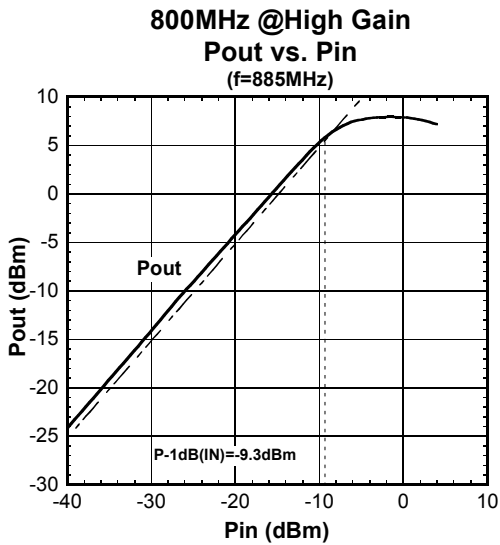

5-5-6 Typical characteristics (800MHz Band High Gain Mode)

Condition: $T_a=+25^{\circ}\text{C}$, $V_{DD}=2.7\text{V}$, $V_{CTL1}=1.8\text{V}$, $V_{CTL2}=0\text{V}$, $V_{CTL3}=1.8\text{V}$

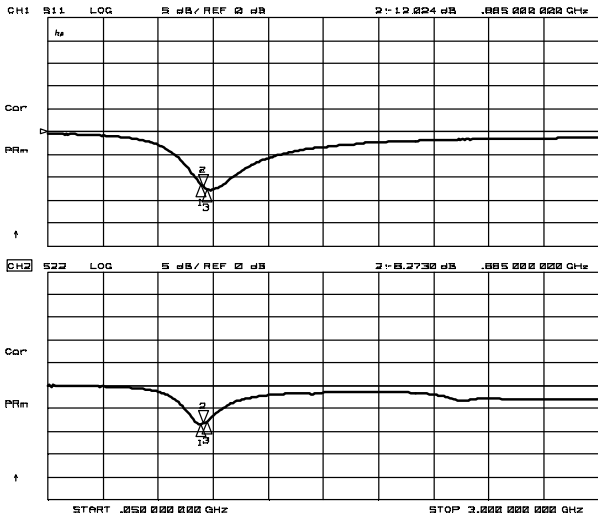

S11, S22

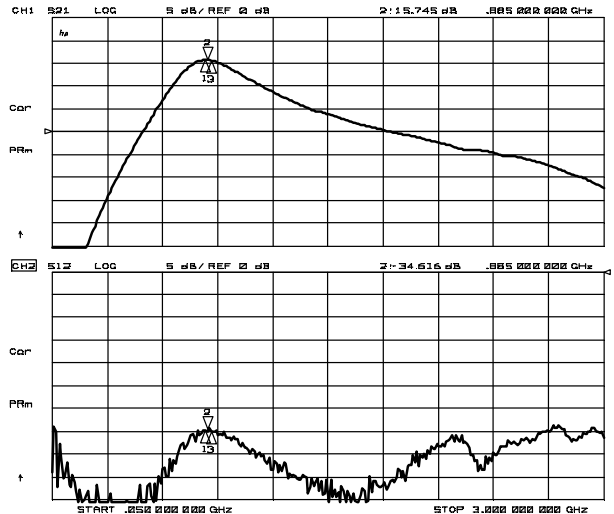

S21, S12

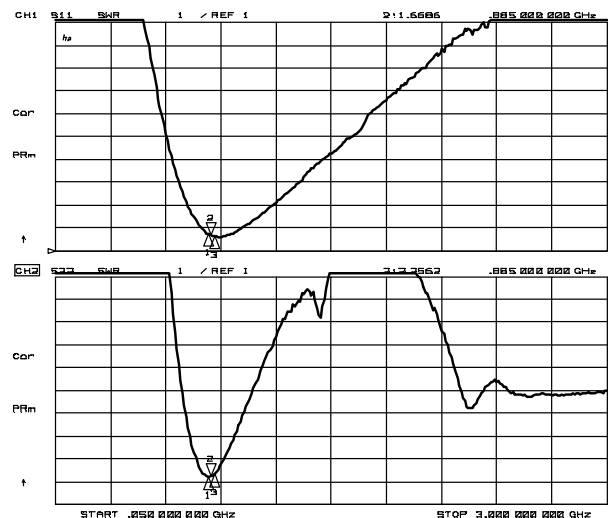

VSWR

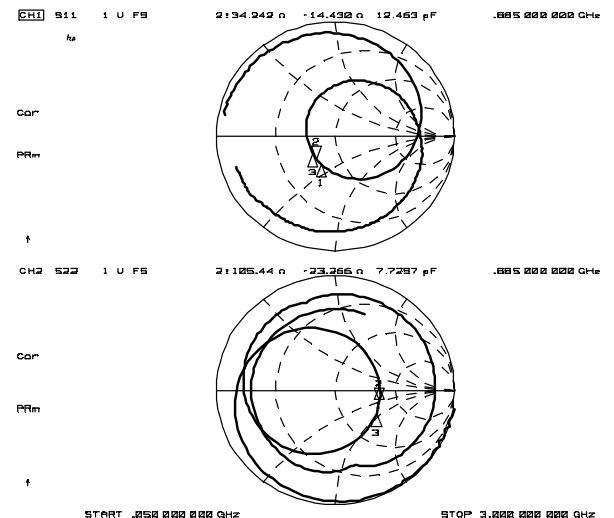

Zin, Zout

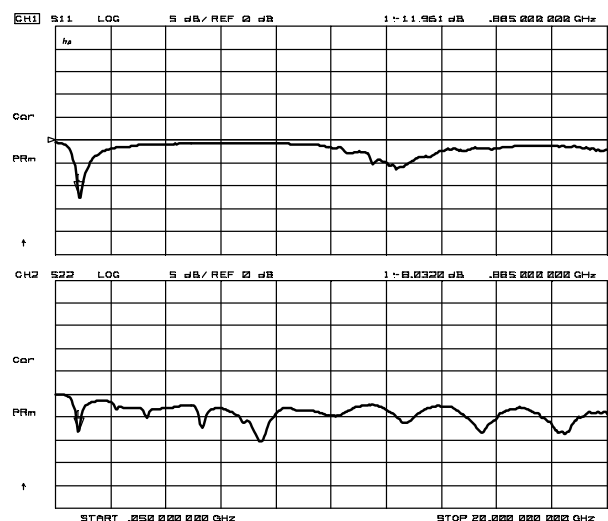

S11, S22

(f=50MHz~20GHz)

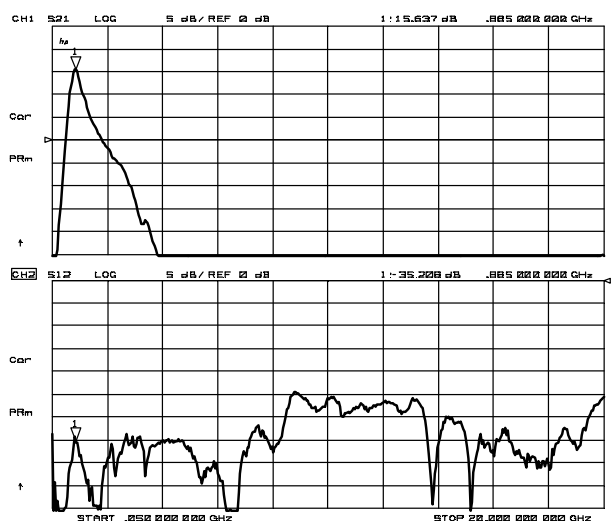

S21, S12

(f=50MHz~20GHz)

5-5-7 Typical characteristics (800MHz Band Low Gain Mode)

Condition: $T_a=+25^{\circ}\text{C}$, $V_{DD}=2.7\text{V}$, $V_{CTL1}=1.8\text{V}$, $V_{CTL2}=0\text{V}$, $V_{CTL3}=0\text{V}$

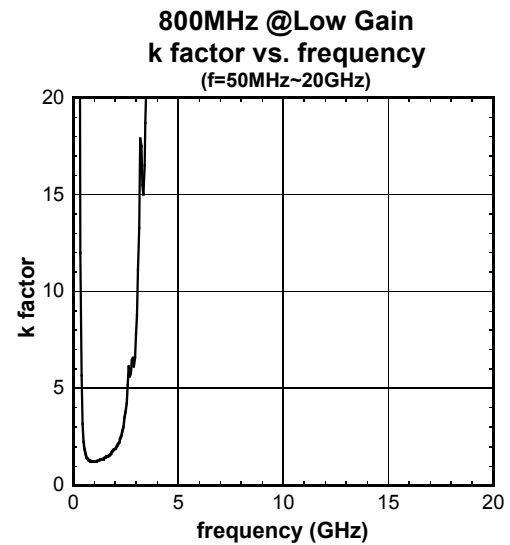
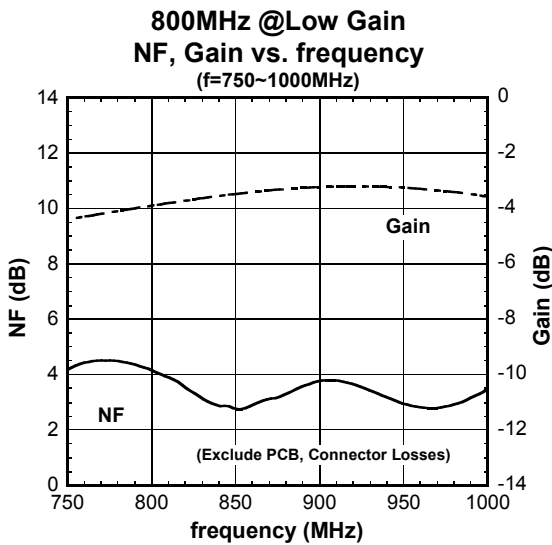
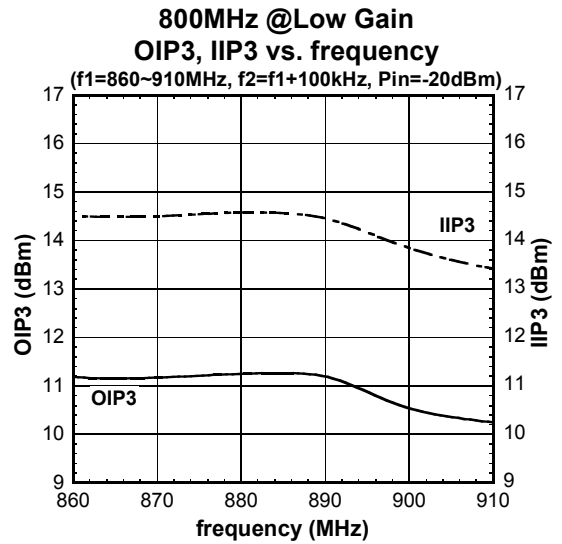
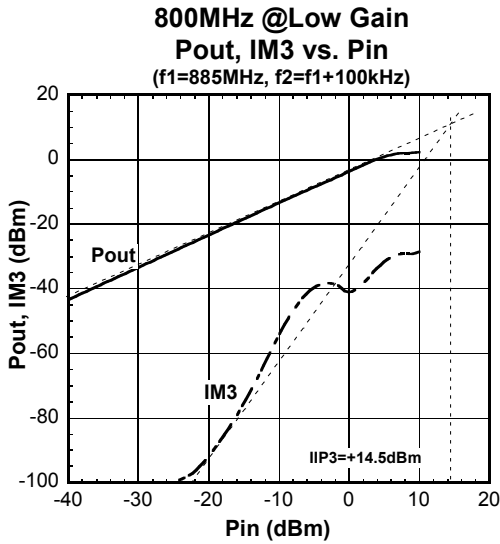
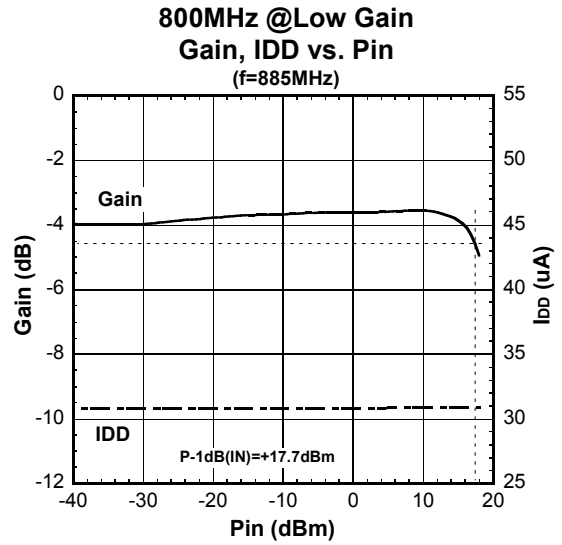
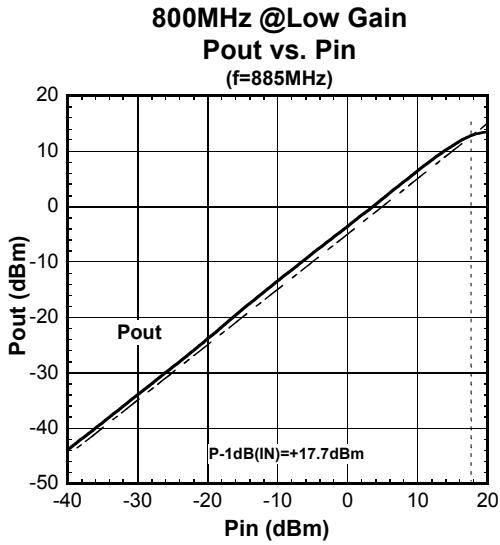

5-5-8 Typical characteristics (800MHz Band Low Gain Mode)

Condition: $T_a = +25^\circ\text{C}$, $V_{DD} = 2.7\text{V}$, $V_{CTL1} = 1.8\text{V}$, $V_{CTL2} = 0\text{V}$, $V_{CTL3} = 0\text{V}$

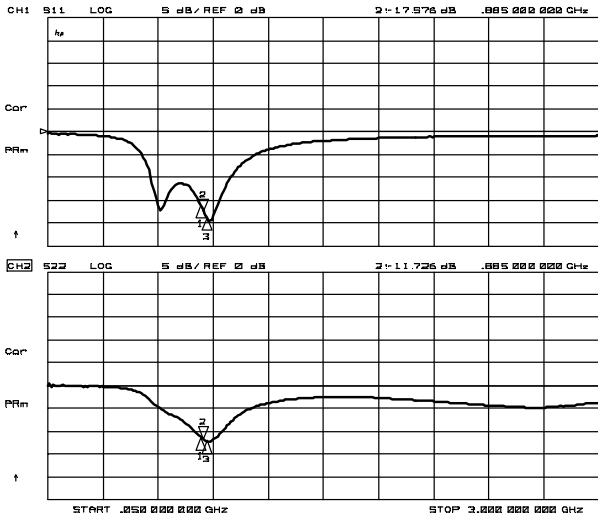

S11, S22

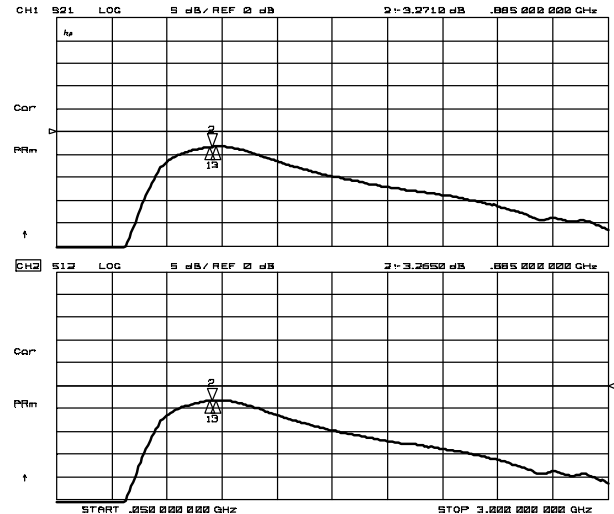

S21, S12

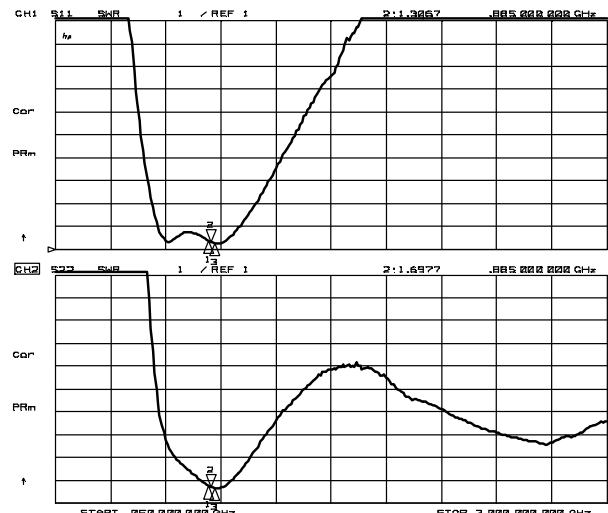

VSWR

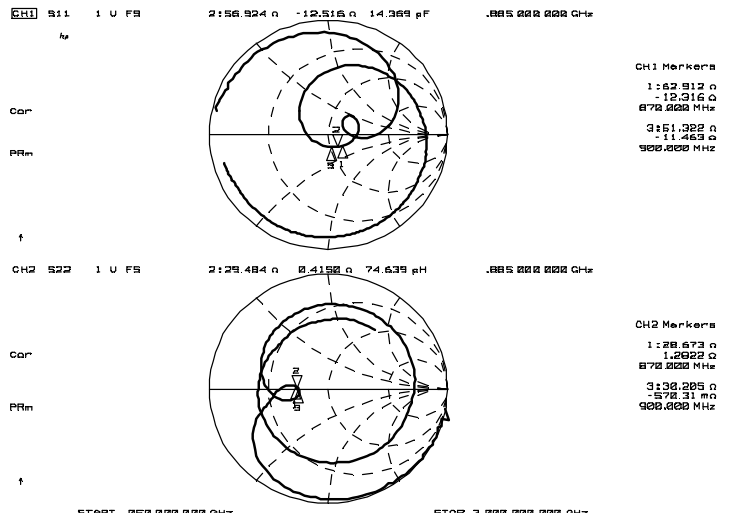

Zin, Zout

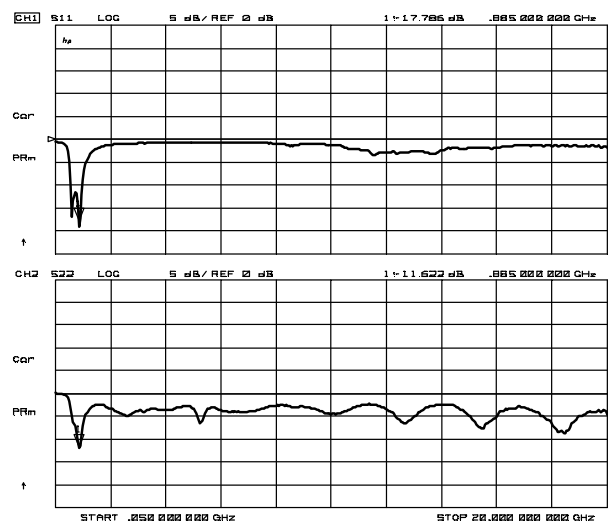

S11, S22
(f=50MHz~20GHz)

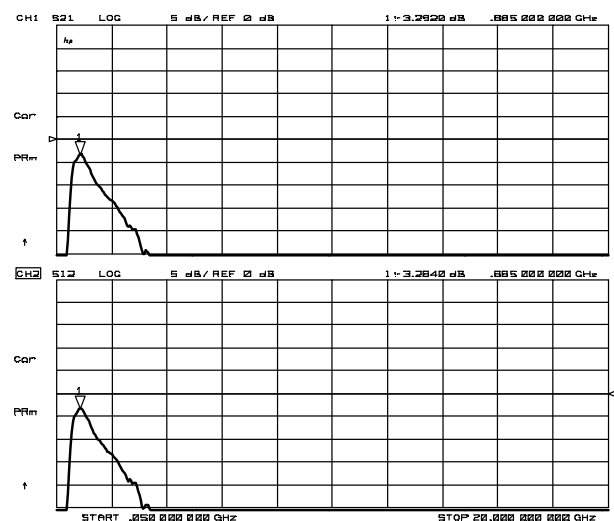

S21, S12
(f=50MHz~20GHz)

5-5-9 Typical characteristics (1.8GHz Band High Gain Mode)

Condition: $T_a=+25^{\circ}\text{C}$, $V_{DD}=2.7\text{V}$, $V_{CTL1}=0\text{V}$, $V_{CTL2}=1.8\text{V}$, $V_{CTL3}=1.8\text{V}$

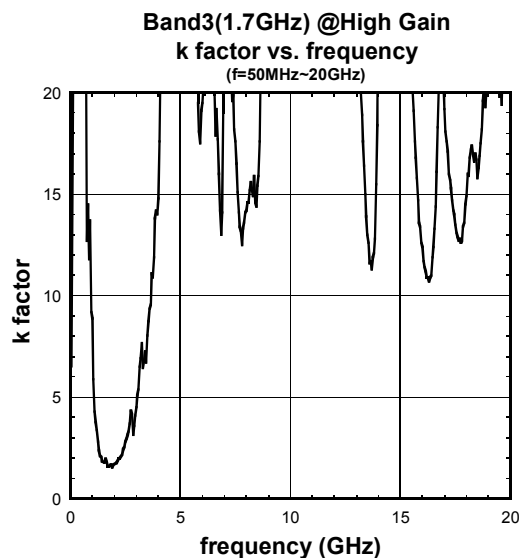
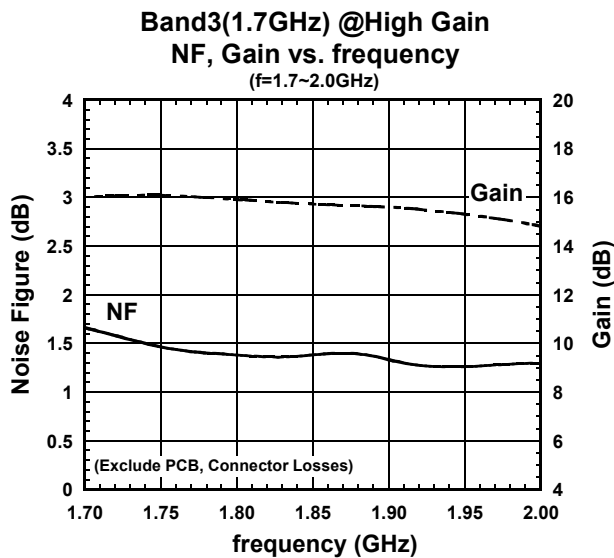
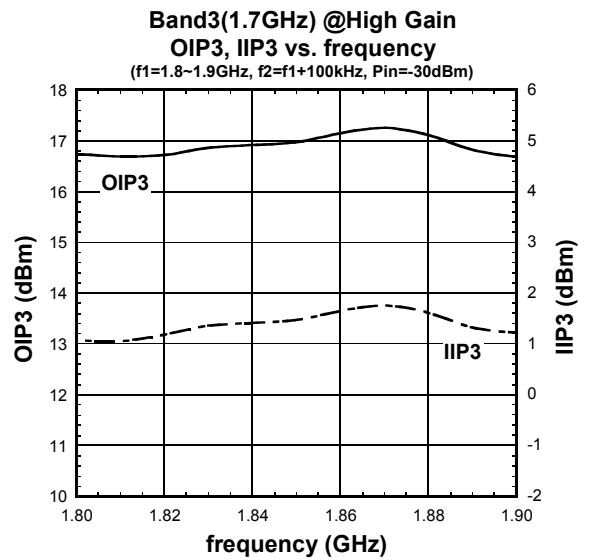
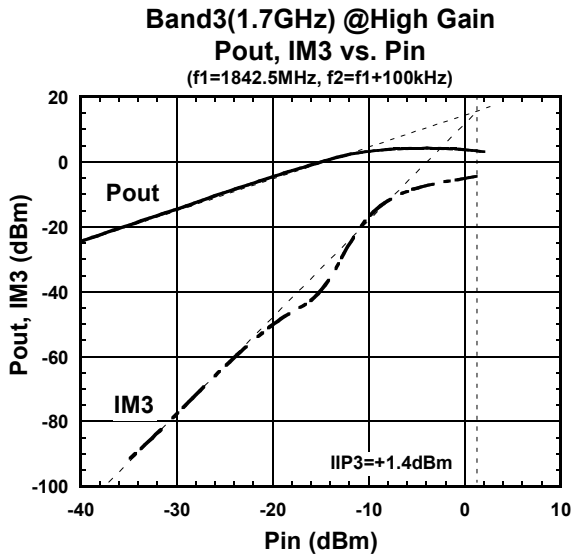
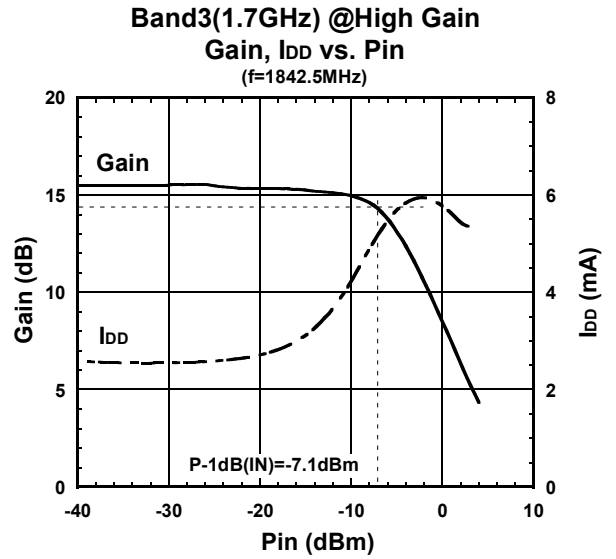
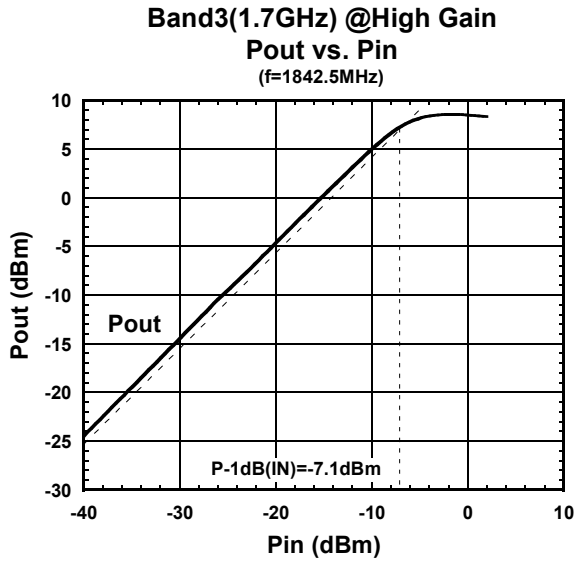

5-5-10 Typical characteristics (1.8GHz Band High Gain Mode)

Condition: $T_a=+25^{\circ}\text{C}$, $V_{DD}=2.7\text{V}$, $V_{CTL1}=0\text{V}$, $V_{CTL2}=1.8\text{V}$, $V_{CTL3}=1.8\text{V}$

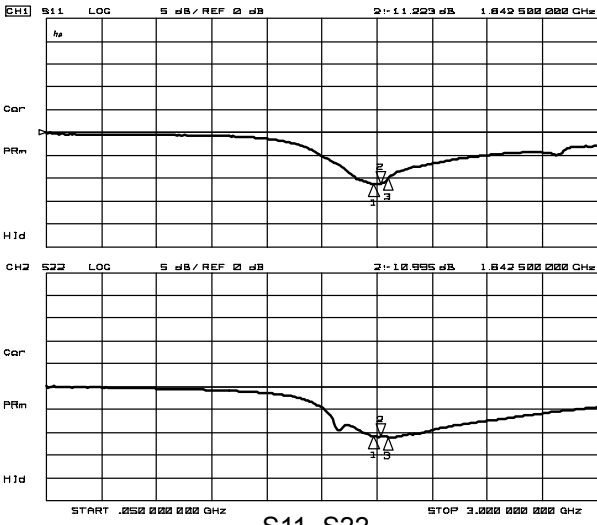

S11, S22

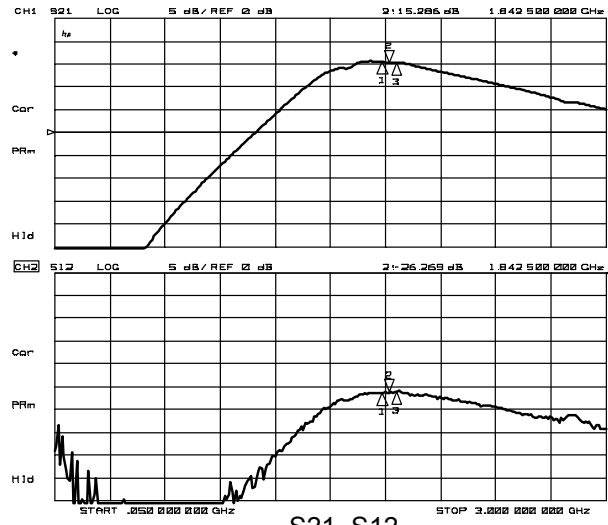

S21, S12

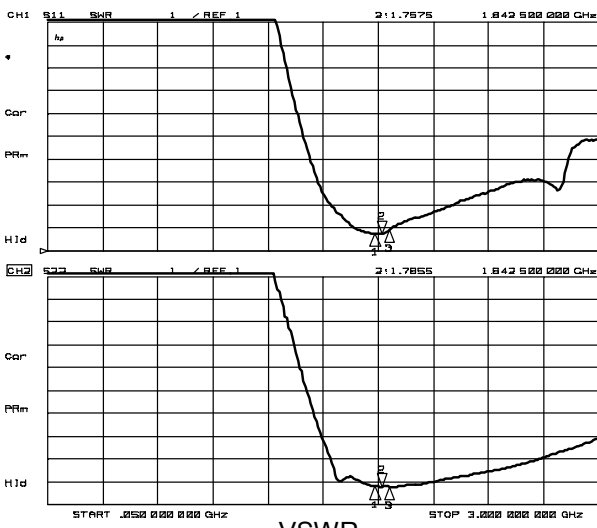

VSWR

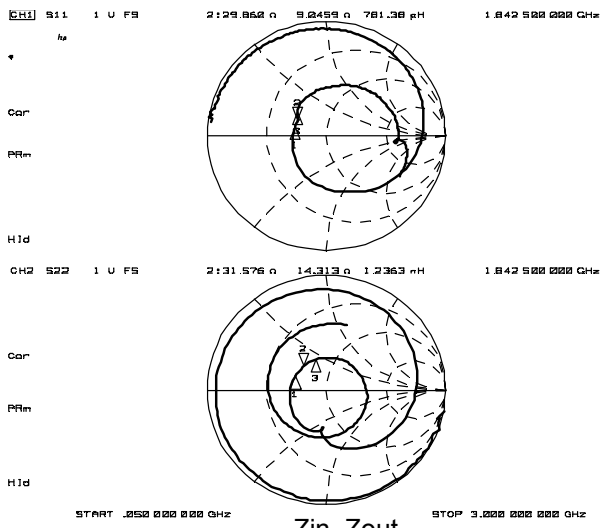

Zin, Zout

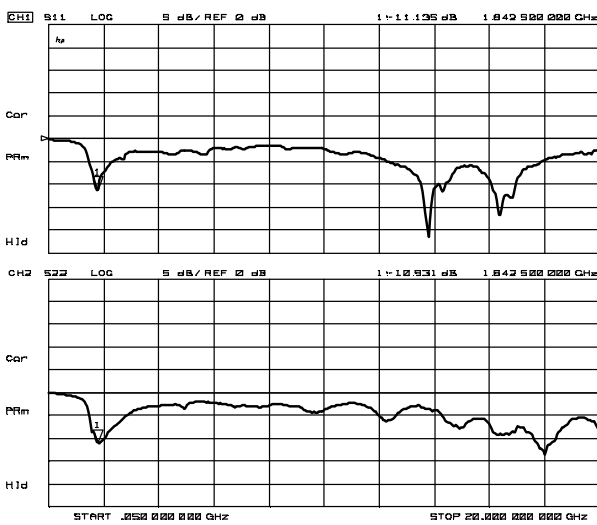

S11, S22
(f=50MHz~20GHz)

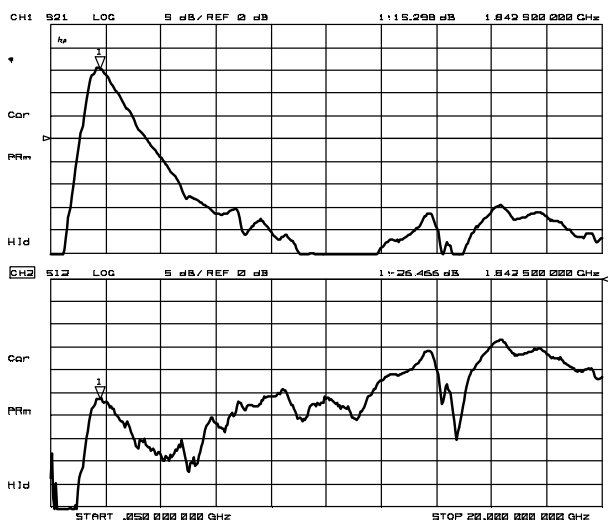

S21, S12
(f=50MHz~20GHz)

5-5-11 Typical characteristics (1.8GHz Band Low Gain Mode)

Condition: $T_a=+25^{\circ}\text{C}$, $V_{DD}=2.7\text{V}$, $V_{CTL1}=0\text{V}$, $V_{CTL2}=1.8\text{V}$, $V_{CTL3}=0\text{V}$

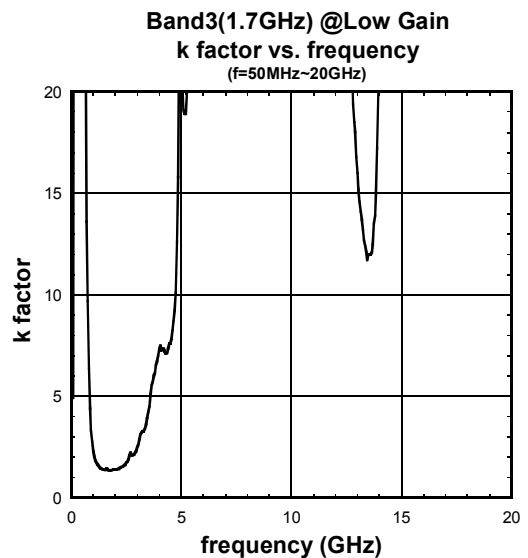
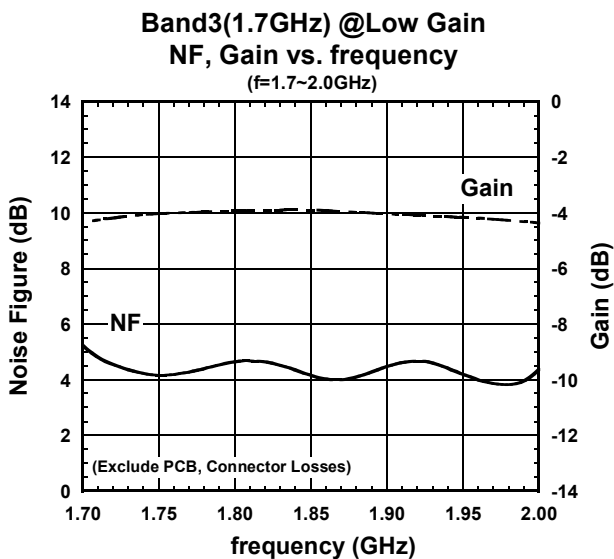
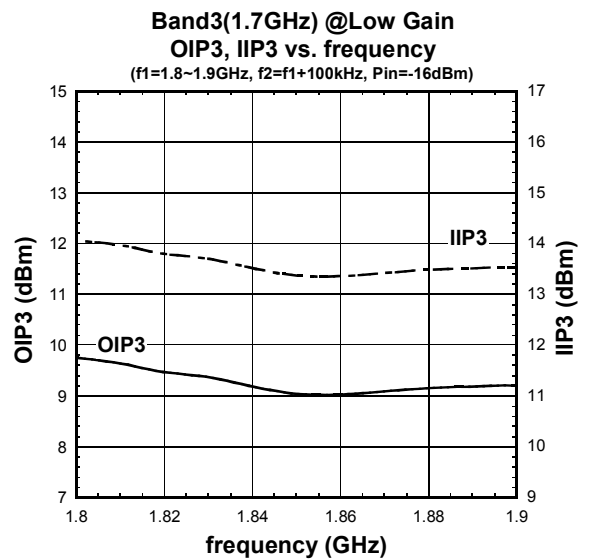
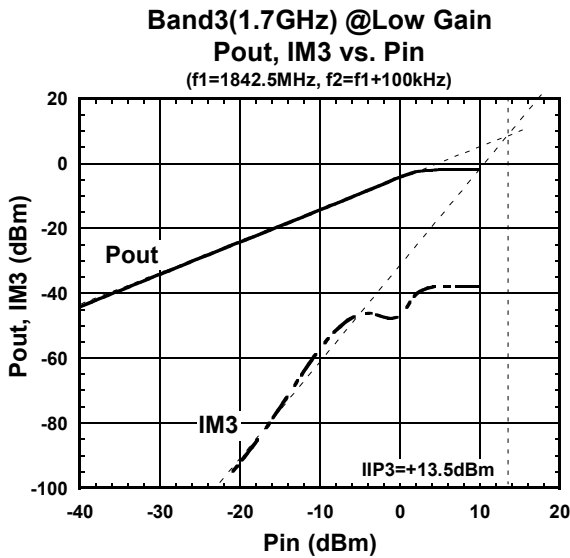
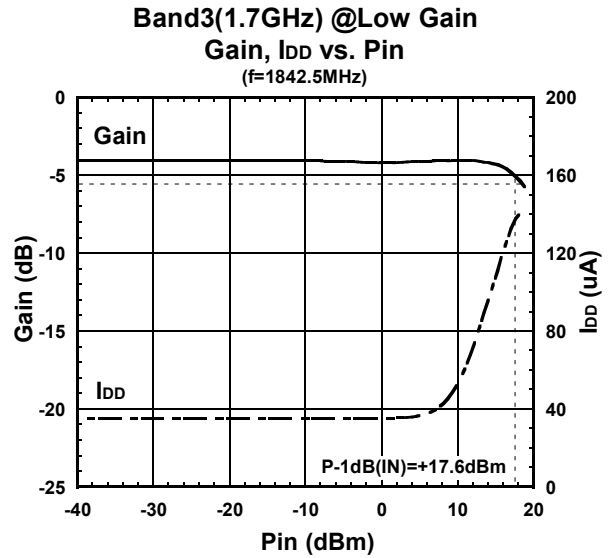
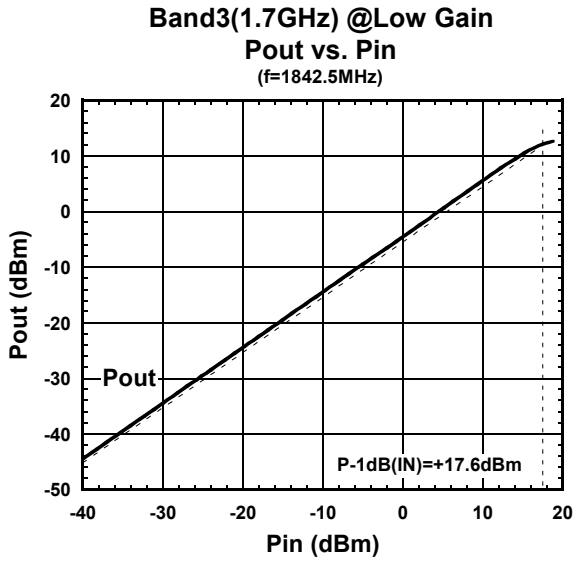

5-5-12 Typical characteristics (1.8GHz Band Low Gain Mode)

Condition: $T_a=+25^{\circ}\text{C}$, $V_{DD}=2.7\text{V}$, $V_{CTL1}=0\text{V}$, $V_{CTL2}=1.8\text{V}$, $V_{CTL3}=0\text{V}$

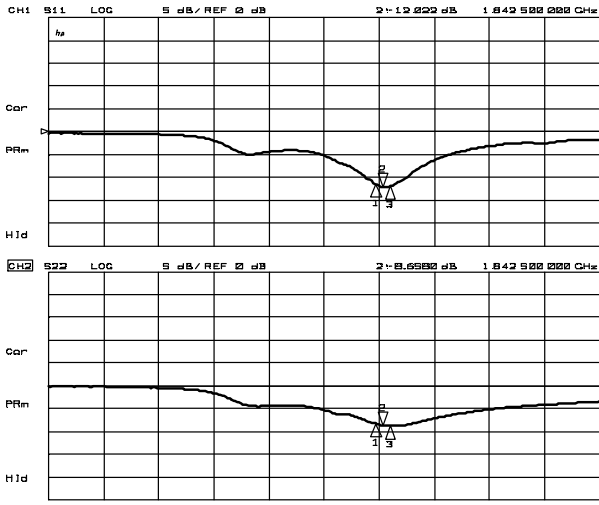

S11, S22

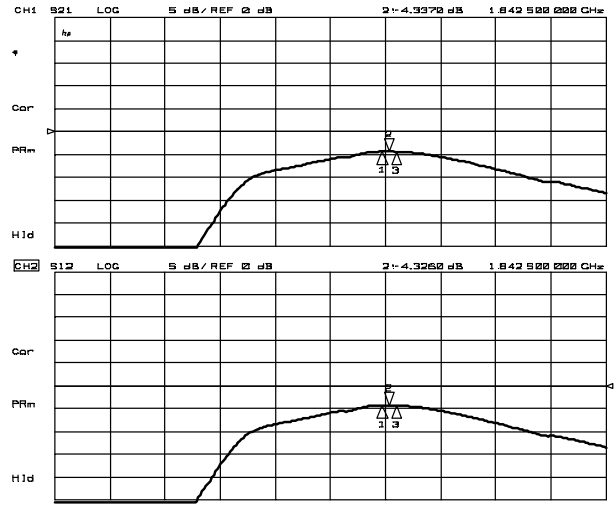

S21, S12

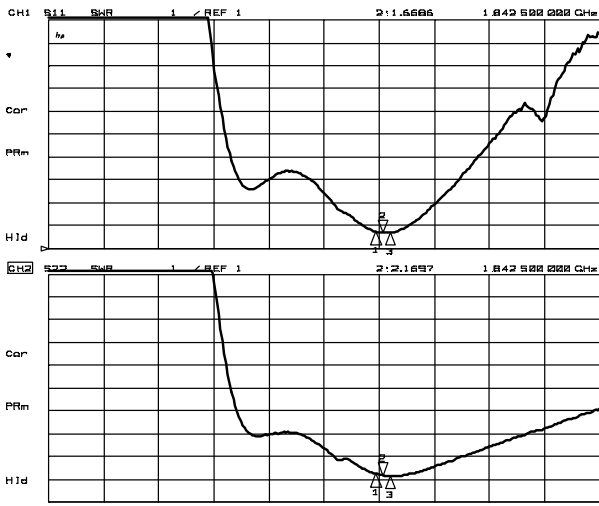

VSWR

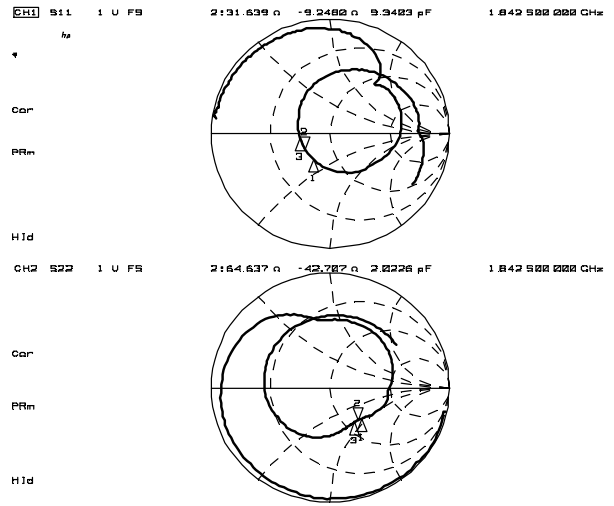

Zin, Zout

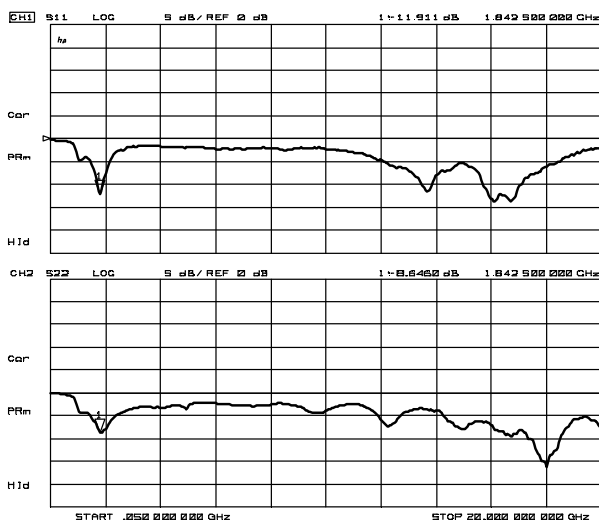

S11, S22
(f=50MHz~20GHz)

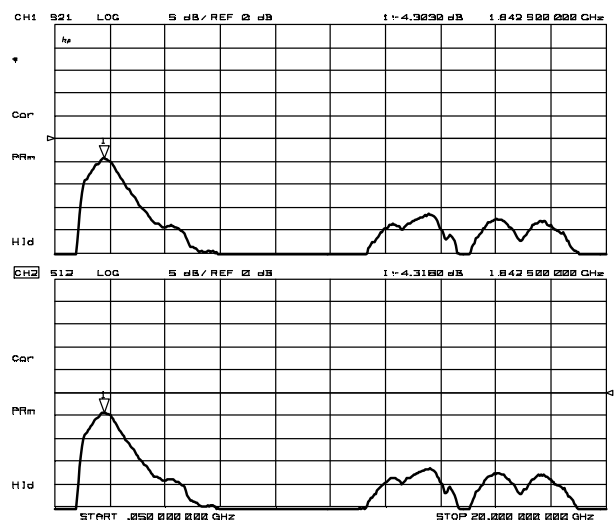

S21, S12
(f=50MHz~20GHz)

5-6 Application circuit

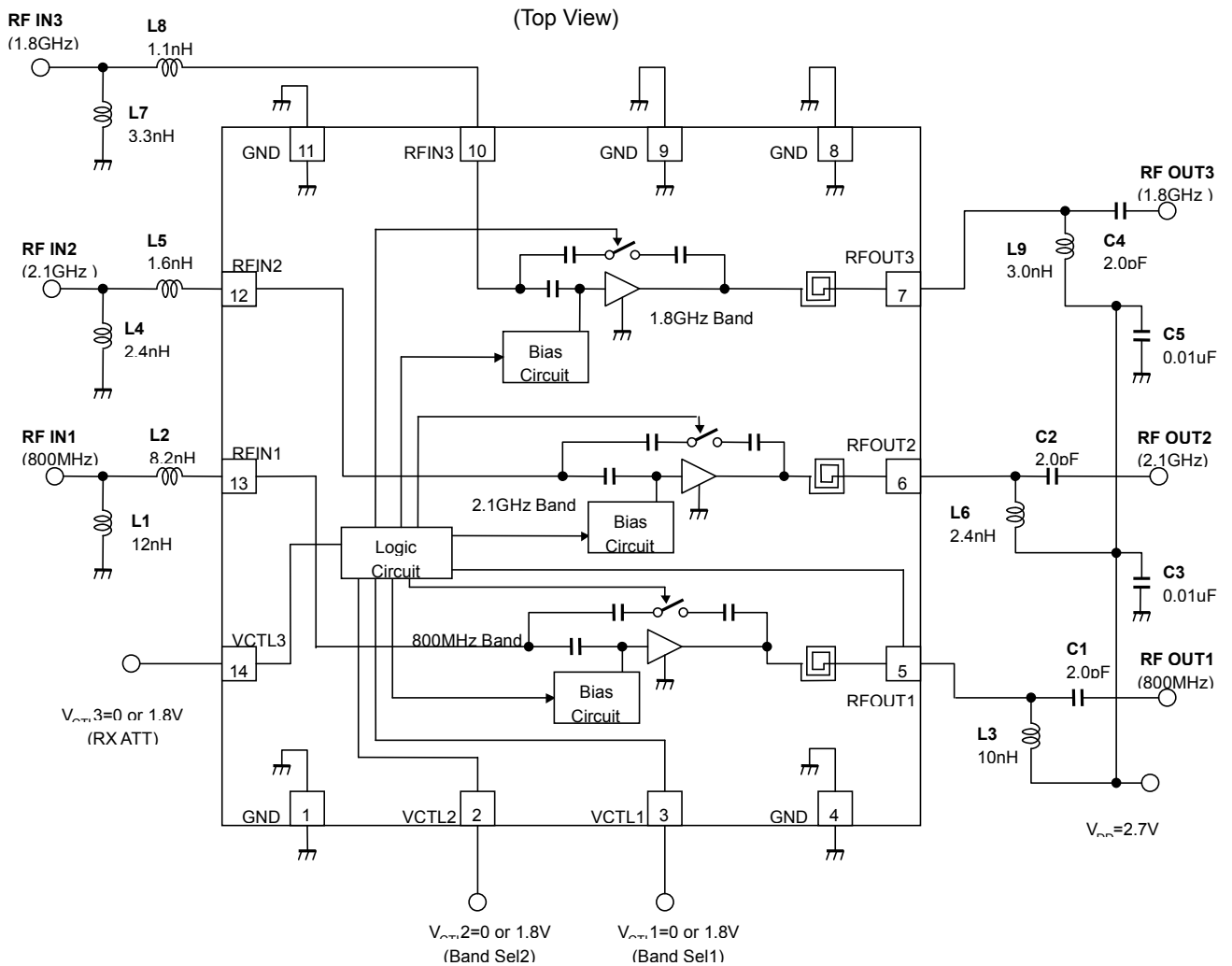

Parts List

Parts ID	Comments
L1, L2, L4 ~L9	MURATA (LQP03T Series)
L3	TDK (MLK0603 Series)
C1~C5	MURATA (GRM03 Series)

5-7 Evaluation board

(Top View)

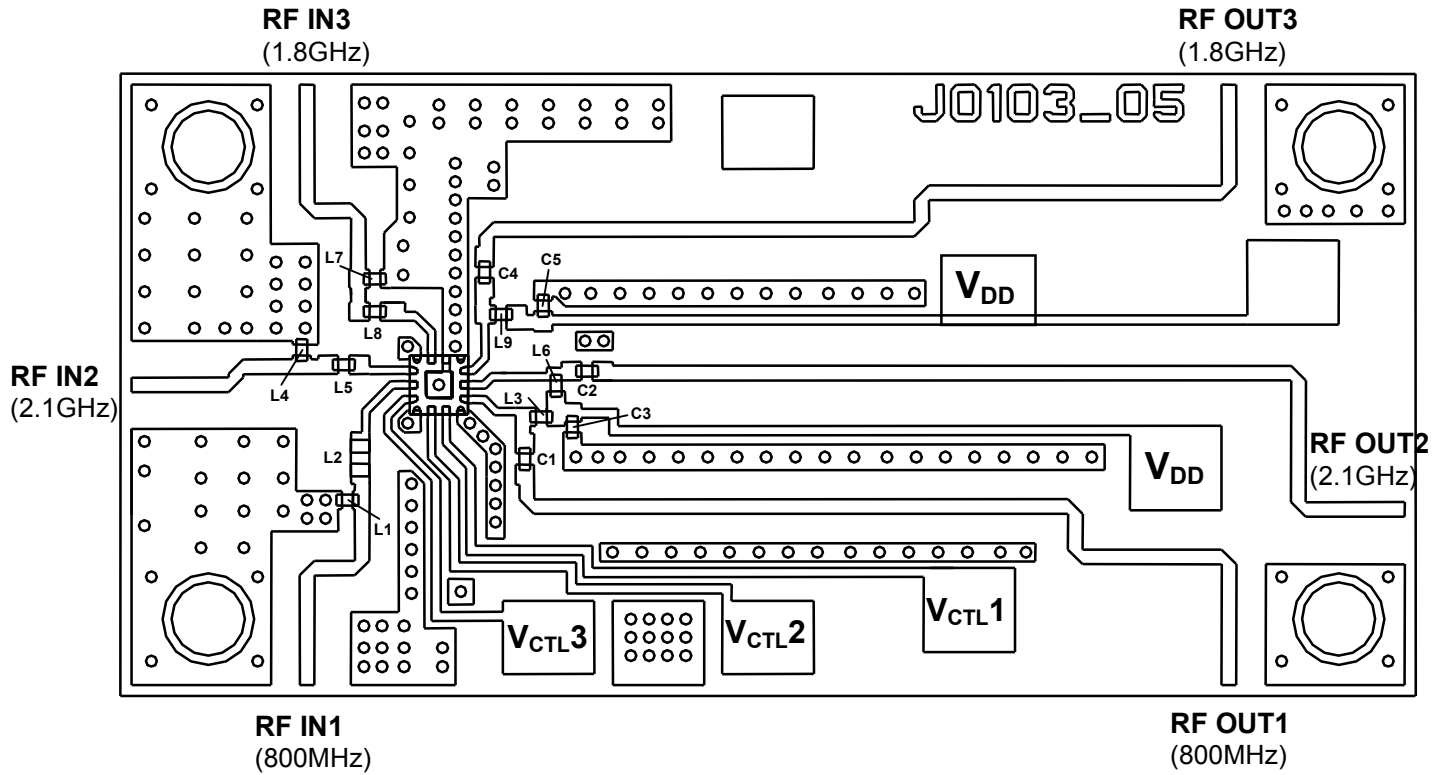

PCB (FR-4):

$t=0.2\text{mm}$

MICROSTRIP LINE WIDTH=0.4mm ($Z_0=50\text{ohm}$)

PCB SIZE=35.4mm x 17.0mm

CAUTION

In order not to couple with terminal RFIN and RFOUT, please layout ground pattern under the IC.